

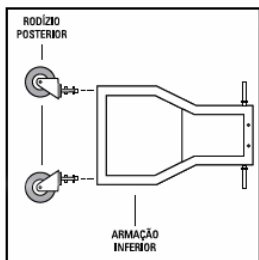

# CARRINHO ERGÔNOMICO PARA CHAVE DE IMPACTO 1"<sup>3/8</sup> CÓD.: 0761100000

## VISTA EXPLODIDA

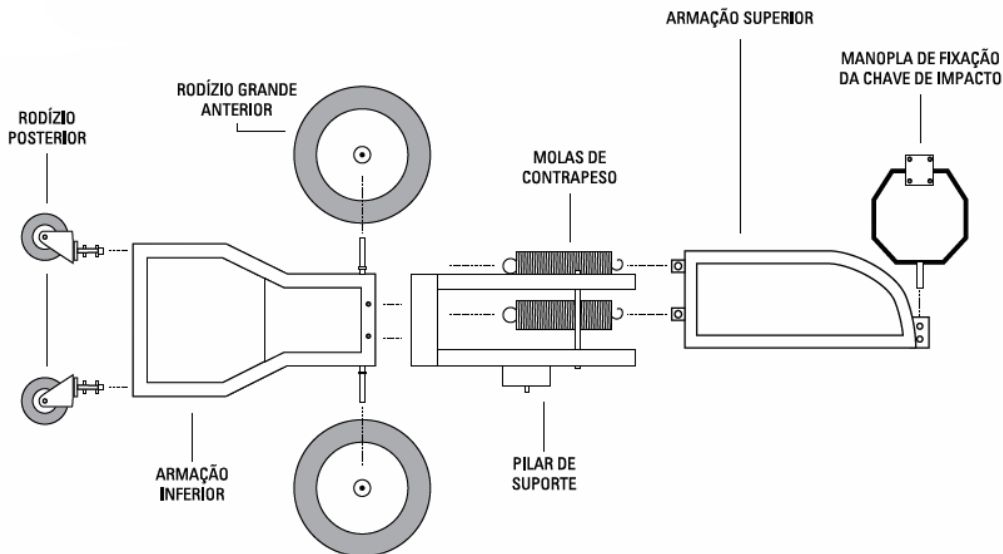

1 - Fixe os rodízios menores nos furos localizados na armação inferior.

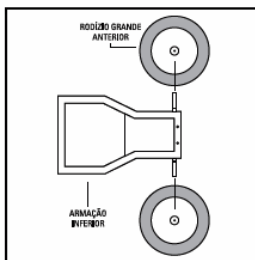

2 - Fixe os rodízios grandes nas hastes localizadas na armação inferior.

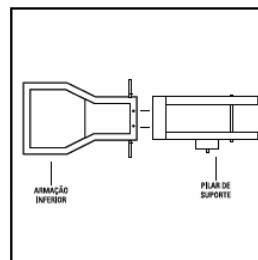

3 - Fixe o suporte vertical (pilar) na armação inferior, nos furos localizados entre o eixo dos rodízios grandes.

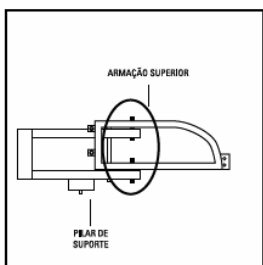

4 - Fixe a armação superior no suporte vertical (pilar).

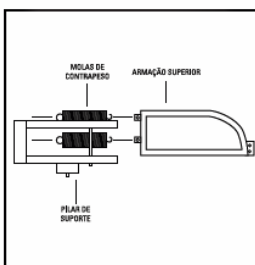

5 - Utilize os ganchos para fixar as molas nas alças, unindo a armação superior e o suporte vertical.

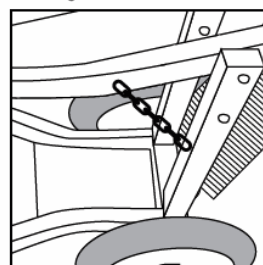

6 - Utilize a corrente para travar a armação superior e limitar a altura.

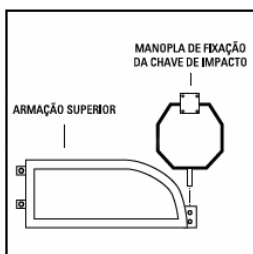

7 - Prenda a manopla entre a chave de impacto e a alça da ferramenta e em seguida, encaixe a manopla na armação superior.

## CARRINHO MONTADO

